

Digi Doser Duo 5

4309539

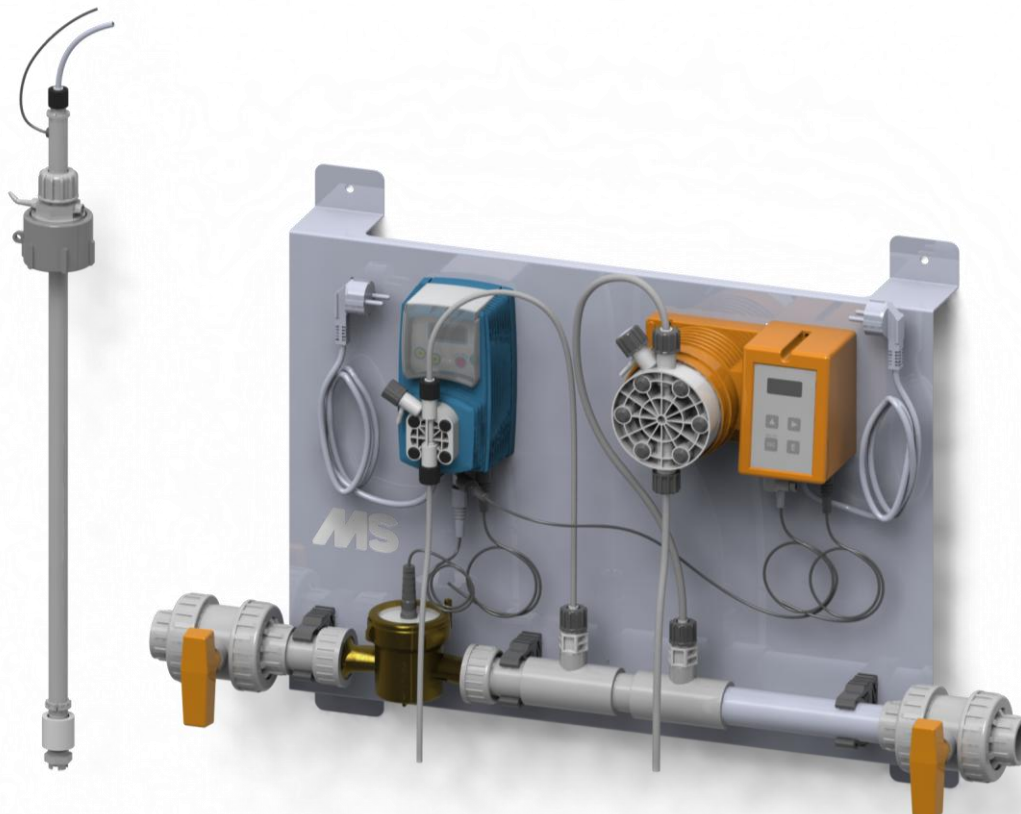

MS Water Solutions

EN **Digi Doser Duo 5**
Operating instructions3



Digi Doser Duo 5

FOREWORD

Product description

Digi Doser Duo 5 is a dosing system for adding both Di-O-Clean and Goldfeed to drinking water systems. The system is equipped with 2 digital diaphragm pumps, which dispense the right amount of Di-O-Clean and/or Goldfeed in the water pipe, based on pulses from a water meter. The dosing system is especially designed to dispense Di-O-Clean and Gold Feed in a simple and accurate way, simultaneously or sequentially, and without need to change products.

TABLE OF CONTENTS

1. The device	3
1.1 Diagram of parts.....	3
1.2 Parts list.....	4
1.3 Articles included	5
2. Installation instructions	6
2.1 Preparation	6
2.2 Fitting the device	7
3. Setting the device into operation	9
3.1. Venting and starting the device	9
3.2 Technical data for the pump	11
4. Settings	11
4.1 Factory settings	11
5. Maintenance	22
5.1 Cleaning the pump	22
6. Trouble shooting	22

Guarantee

- The firm Schippers guarantees this product against manufacturing defects for a period of 12 months.
- The guarantee applies to both mechanical and electronic components as well as for working hours.
- Shipments to the user are covered by the guarantee.
- Movements are at the user's risk.
- The guarantee is valid for the first owner, at the original place of installation.

Excluded from the guarantee:

- Damage caused by improper installation, faults in the pipeline and high water pressure or pressure surges.
- Damage caused by frost, fire, accident, unreasonable use or negligence on the part of the user.
- Damage caused by the presence of iron, water hardness, algae, organic matter or other substances in the water for which the appliance is not suitable. In some cases, water treatment should be provided.

1. THE DEVICE

1.1 Diagram of parts

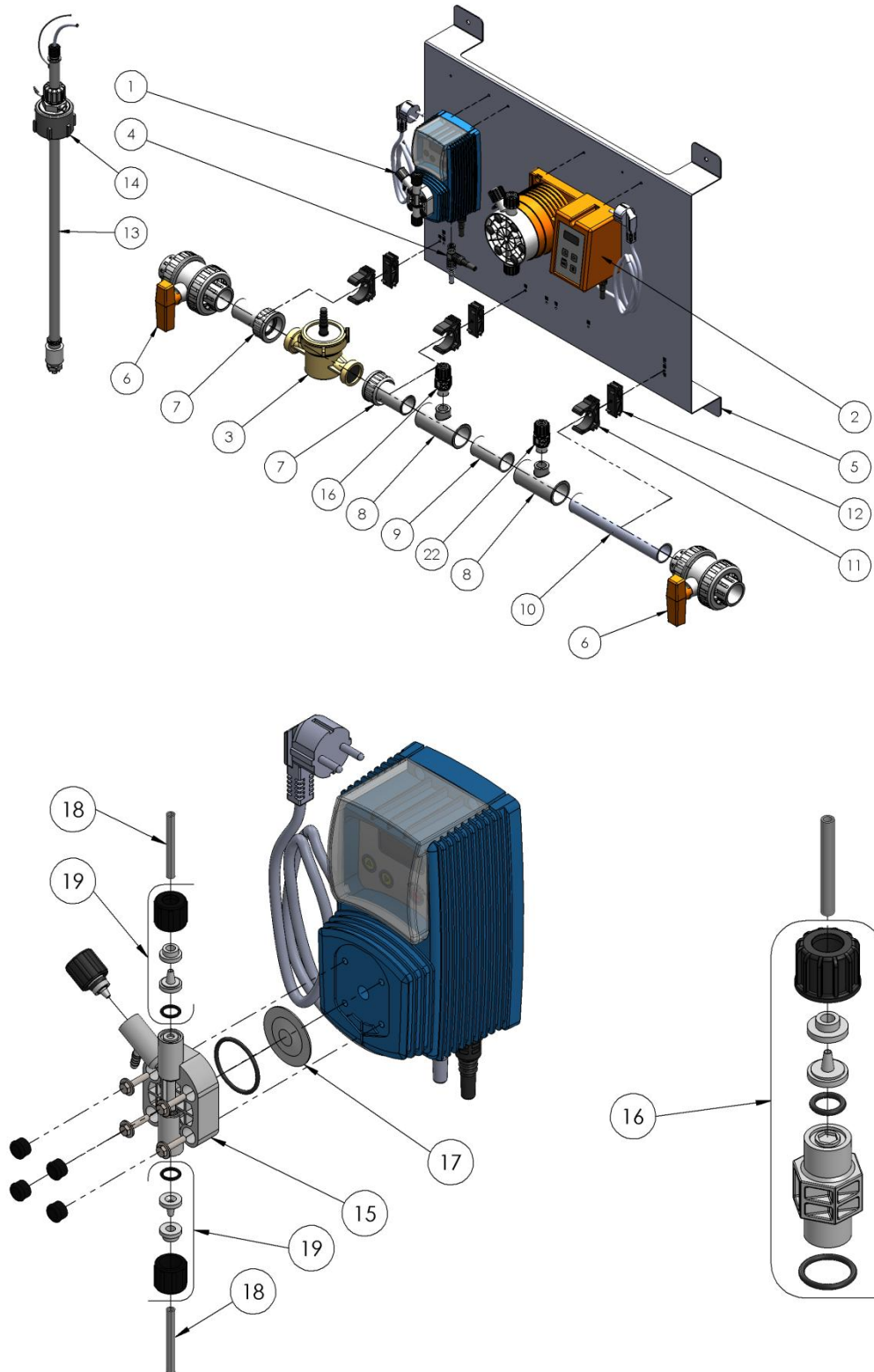

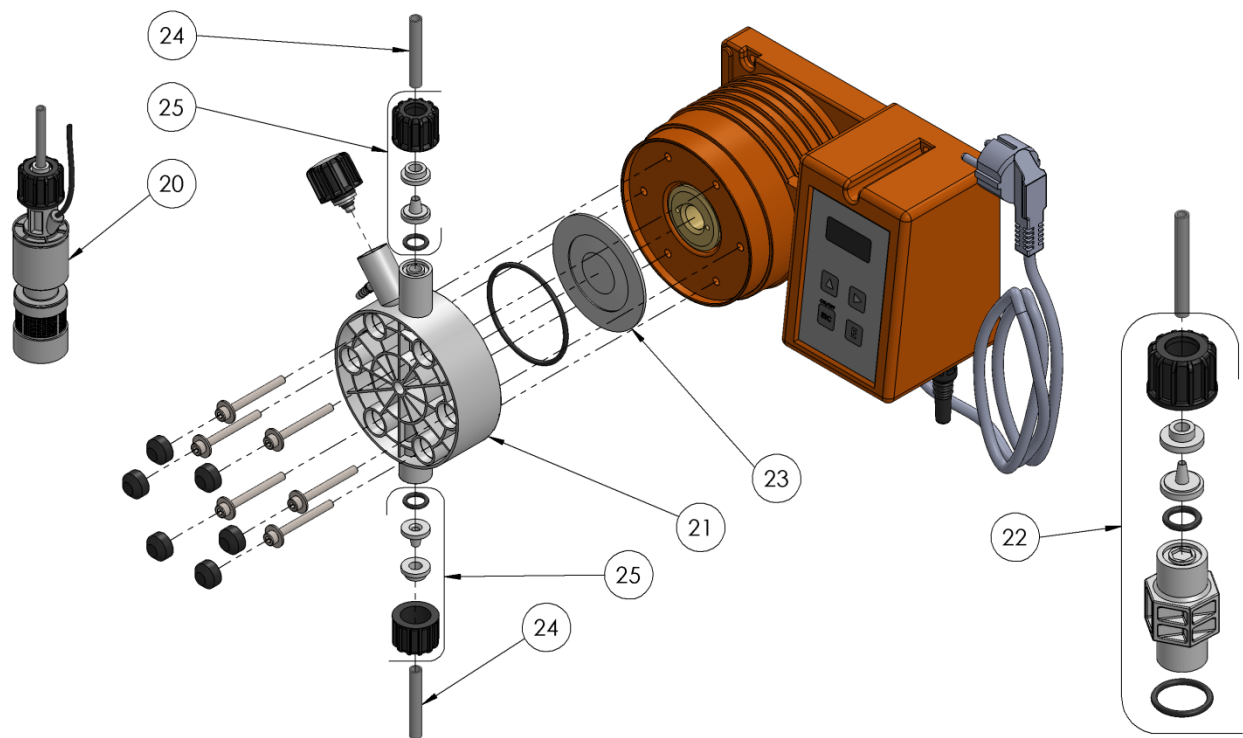

Fig. 1.1 Diagram of parts

1.2 Parts list

The parts list below relates to the diagram of parts in paragraph 1.1.

Digi Doser Duo 5 Spare Parts		
Code	Article number:	Description
1	8800410	Di-O-Clean pump, 2.7 litres, 8 bar
2	8800413	Acid pump, 20 litres, 4 bar
3	8804515	Water meter 1¼", 5 m3/h
4	8800610	Signal splitter, with cable
5	8804083	Mounting plate, SS, 800 x 500 mm
6	8800250	Ball valve, PVC, 40 mm
7	8800221	¾-coupling 40 x 1½"
8	8800244	T-piece 90° 40 x ½" x 40
9	8800384	PVC pipe, 40 mm, L = 270 mm
10	8800384	PVC pipe, 40 mm, L = 230 mm
11	8800293	Hose clip, 40 mm
12	8800253	Spacer, 40 mm
13	8804546	Dry run protection, LASP, 72 cm
14	8804534	Di-O-Clean can adapter
15	8804514	Digi Doser Di-O Pump head, K
16	8804528	Di-O-Clean Injector, 5 bar, 1/2" 4 x 6
17	8804511	Diaphragm, K
18	8804535	Pressure and suction hose for Digi Doser Di-O, 2 m

19	8804588	Hose fitting kit 3/8" 4 x 6 Di-O
20	8804575	Dry run protection, Acid, 1/2" 6 x 8
21	8804584	Pump head N, Digi Doser, Acid
22	8804579	Acid Injector, 3 bar, 1/2" 6 x 8
23	8804582	Diaphragm N
24	8800449	Suction/Pressure hose 2 m 6 x 8, Digi Doser
25	8804590	Hose fitting kit 1/2" 6 x 8, Acid
-	8804599	Fuse 1 A

Fig. 1.2 Parts list

1.3 Articles included

Wall mounting

- 4 x threaded bolts Ø 8 x 60 mm
- 4 x plugs bolts Ø 8 x 10 mm

Pressure hose

- 1 x hose from dosage pump to injector

Dry-run protection

- 1 x Dry-run protection set

Venting kit

- 1 x 50 cc Syringe
- 1 x transparent hose (syringe to vent valve)

Operating instructions

- 1 x plastic laminated instruction card

2. INSTALLATION INSTRUCTIONS

2.1 Preparation

We advise you to fit a bypass (fig. 2.1.) around the pump's location. In this way, you can continue to use the main pipeline and easily maintain a water supply to your animals during maintenance or in case of any fault.

A supply of clean water and the proper pressure are prerequisites for proper dosing system function. If the water supply is not optimal, you can install an additional water filter and/or pressure regulator (see Fig. 2.1):

1. Water filter (4309555)
2. Pressure regulator (8804001)

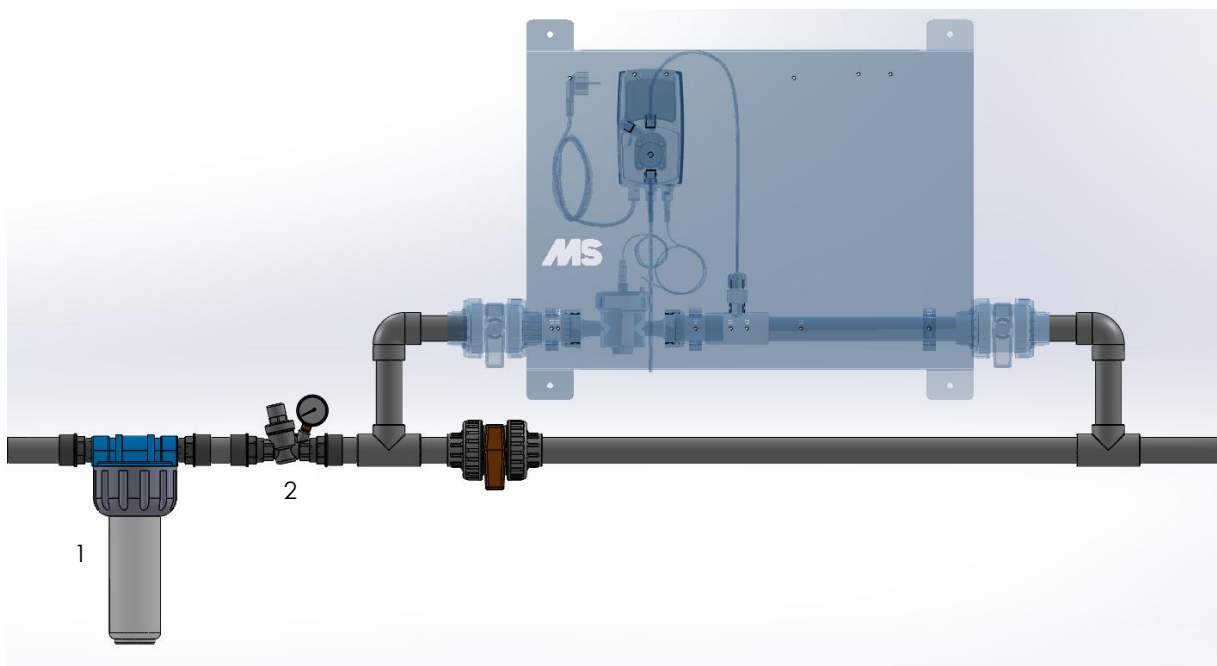

Fig. 2.1. Diagram of the bypass

2.2 Fitting the device

Turn off the water supply and cut away the supply pipeline. Fit the necessary fittings for connecting the pump.

- Mark the four mounting holes (level) on the wall behind.
- Drill four holes (Ø 10 mm) in the wall where you are mounting the device.
- Mount the device on the wall, using the supplied plugs and bolts.
- Connect the water supply to the inlet and the outlet pipe (for treated water) to the outlet. Open the ball valves at the pump inlet and outlet (Figure 1).

2.2.1 Digi Doser Di-O

- Connect the dry-run protection cable to the "level" connector on the dosing pump (Figure 2).
- Connect the suction hose with the dry-run protection to the underside of the pump (Figure 3).
- In the same way, connect the pressure hose to the topside of the pump and to the injector (Figure 4).

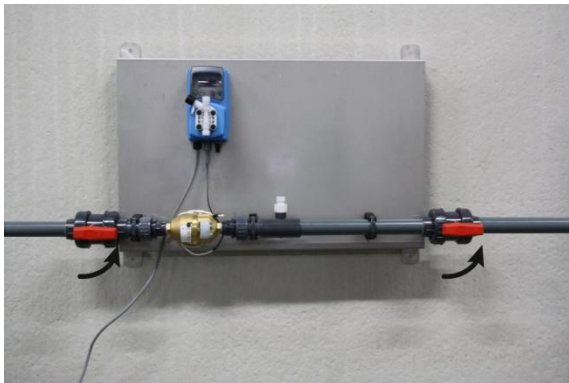

Figure 1: Open the ball valves



Figure 2: Connecting the dry-run protection



Figure 3: Connecting the suction hose

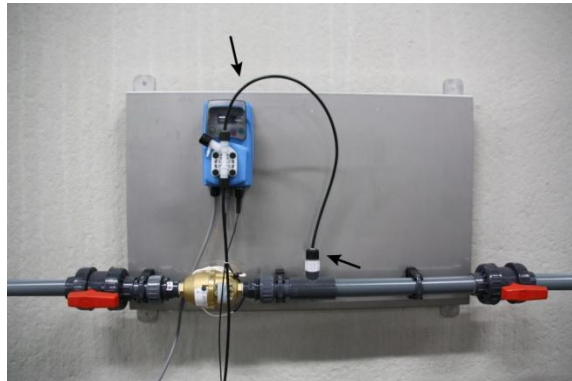

Figure 4: Connecting the pressure hose

2.2.2. Digi Doser Acid

- Connect the dry-run protection cable to the "level" connector on the dosing pump (Figure 5).
- Connect the suction hose with the dry-run protection to the underside of the pump (Figure 6).
- In the same way, connect the pressure hose to the topside of the pump and to the injector (Figure 7).



Figure 5: Connecting the dry-run protection



Figure 6: Connecting the suction hose

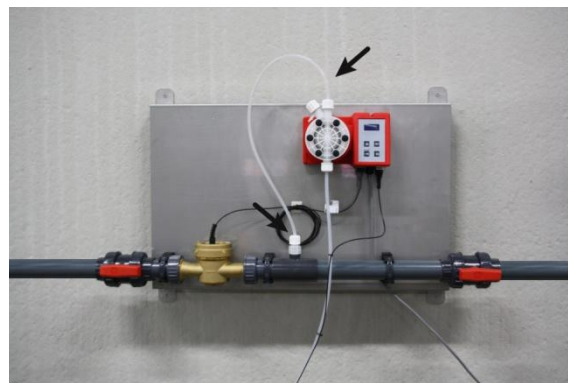

Figure 7: Connecting the pressure hose

3. SETTING THE DEVICE INTO OPERATION

3.1. Venting and starting the device

3.1.1 Digi Doser Di-O

- Switch the pump on (Figure 8) and set the correct dosage (see paragraph 4.1.1.).
- Place the container of Di-O-Clean under the device.
- Connect the suction lance to the container, using the supplied adapter (Figure 9).
- Connect the supplied syringe with the appropriate hose to the vent valve. Open the venting valve on the pump head and use the supplied syringe and tube to suck the air from the system until fluid runs into the syringe (Figure 10).
- Close the venting valve again.
- Press and hold down the right arrow button for 5 seconds. The system will then dispense for 30 seconds, so that the whole system fills with Di-O-Clean (Figure 11).
- The system is ready for use.



Figure 8: Switching the pump on



Figure 9: Connecting the suction lance to the

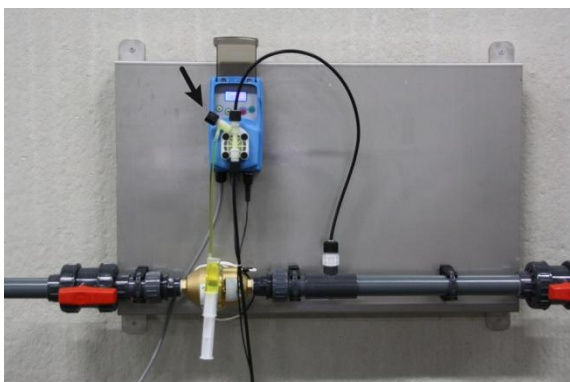

Figure 10: Venting the pump



Figure 11: Filling the pressure hose

3.1.2. Digi Doser Acid

- Switch the pump on (Figure 12) and set the correct dosage (see paragraph 4.1.2.).
- Place the product container under the device.
- Suspend the suction hose with the dry-run protection in the liquid (Figure 13).
- Connect the supplied syringe with the appropriate hose to the vent valve. Open the venting valve on the pump head and use the supplied syringe and tube to suck the air from the system until fluid runs into the syringe (Figure 14).
- Close the venting valve again.
- Press and hold down the right arrow button for 5 seconds. The system will then dispense for 30 seconds, so that the whole system fills with the product (Figure 15).
- The system is ready for use.



Figure 12: Switching the pump on



Figure 13: Put the suction hose in the liquid

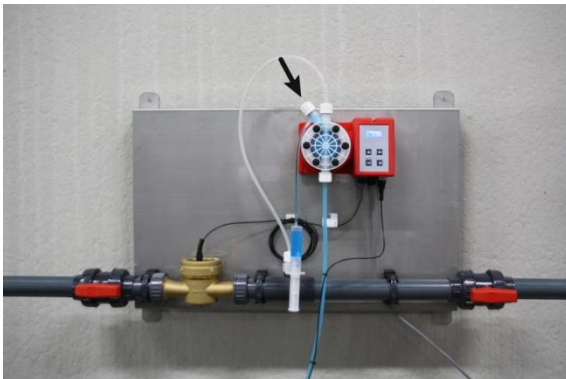

Figure 14: Venting the pump



Figure 15: Filling the pressure hose

3.2 Technical data for the pump

Specification	Digi Doser Di-O 5 (blue)	Digi Doser Acid 5 (red)
Max pressure	8 bar	4 bar
Minimum Flow rate	100 litres per hour	
Nominal flow rate	5,000 litres per hour	
Maximum flow rate	10,000 litres per hour	
Maximum injections per minute	180	120
Injections per impulse	0.25 cc at 5 bar	2.80 cc at 5 bar
Pump output	2.7 litres per hour at 5 bar	20 litres per hour at 4 bar
Working temperature	from 0 to 45 °C	
Voltage	230 VAC	
Power use	16 W	27 W
Dimension mm	941 mm x (H) 500 mm x (D) 237 mm	
Weight	± 17 kg	
Protection rating	IP 65	
In/output connections	40 mm PVC	

4. SETTINGS

4.1 Factory settings

The following settings are pre-set in your dosage pump:

Settings	Digi Doser Di-O 5 (blue)	Digi Doser Acid 5 (red)
CC per impulse (CC/ST)	0.25	2.80
TEST	100 impulses	50 impulses
Reserve in supply tank (LEVEL)	02.000 litres	02.000 litres
Water meter pulses (WMETER)	048 per litre	048 per litre
Unit (UNIT)	litre	litre
Password (PASSWORD)	0000	0000
MODE (4)	PPM	PERC
Dosage	PPM	00.20%
CONC%	100	100
Upkeep	NO	N/A

Schema 1

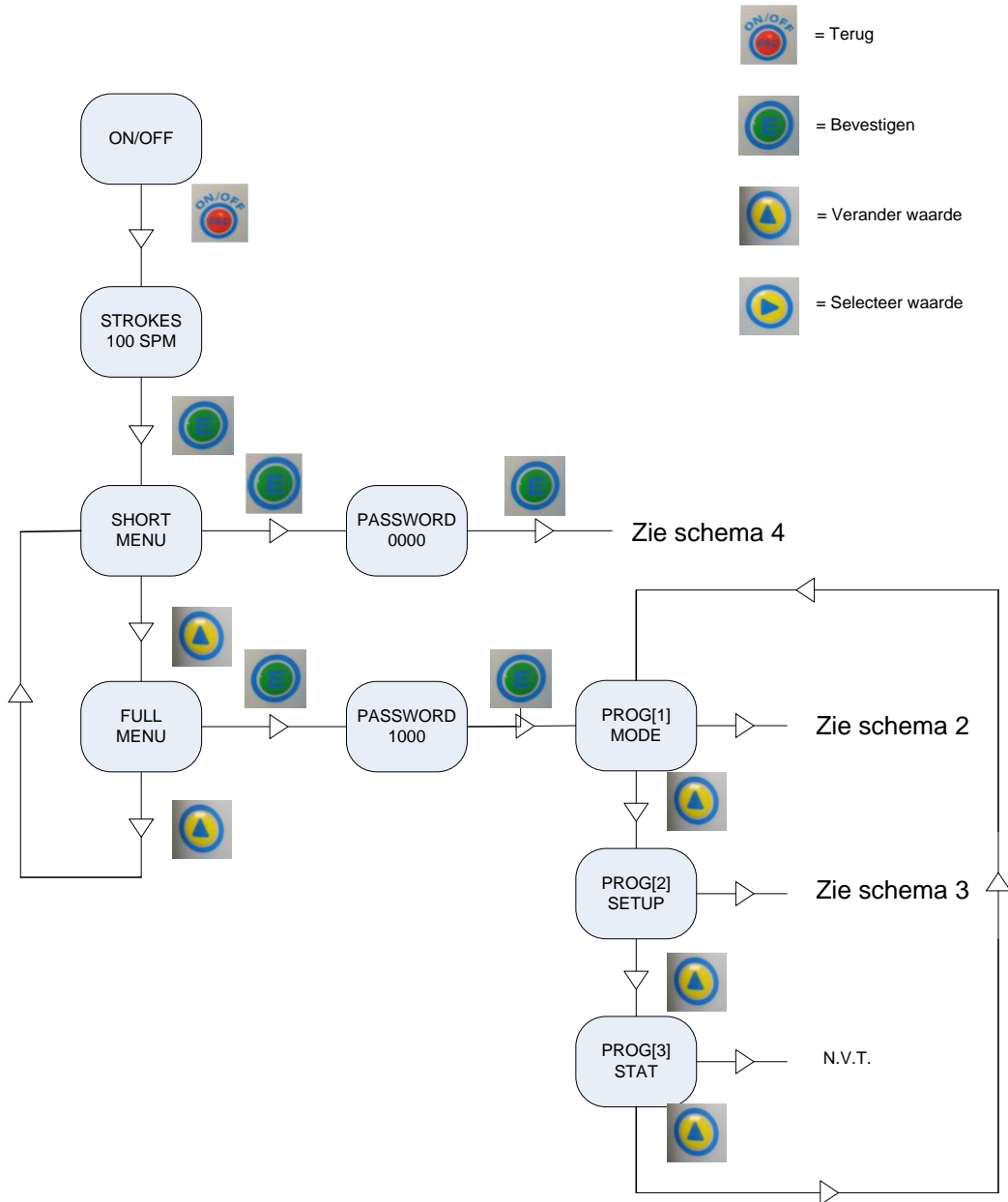

Schema 2

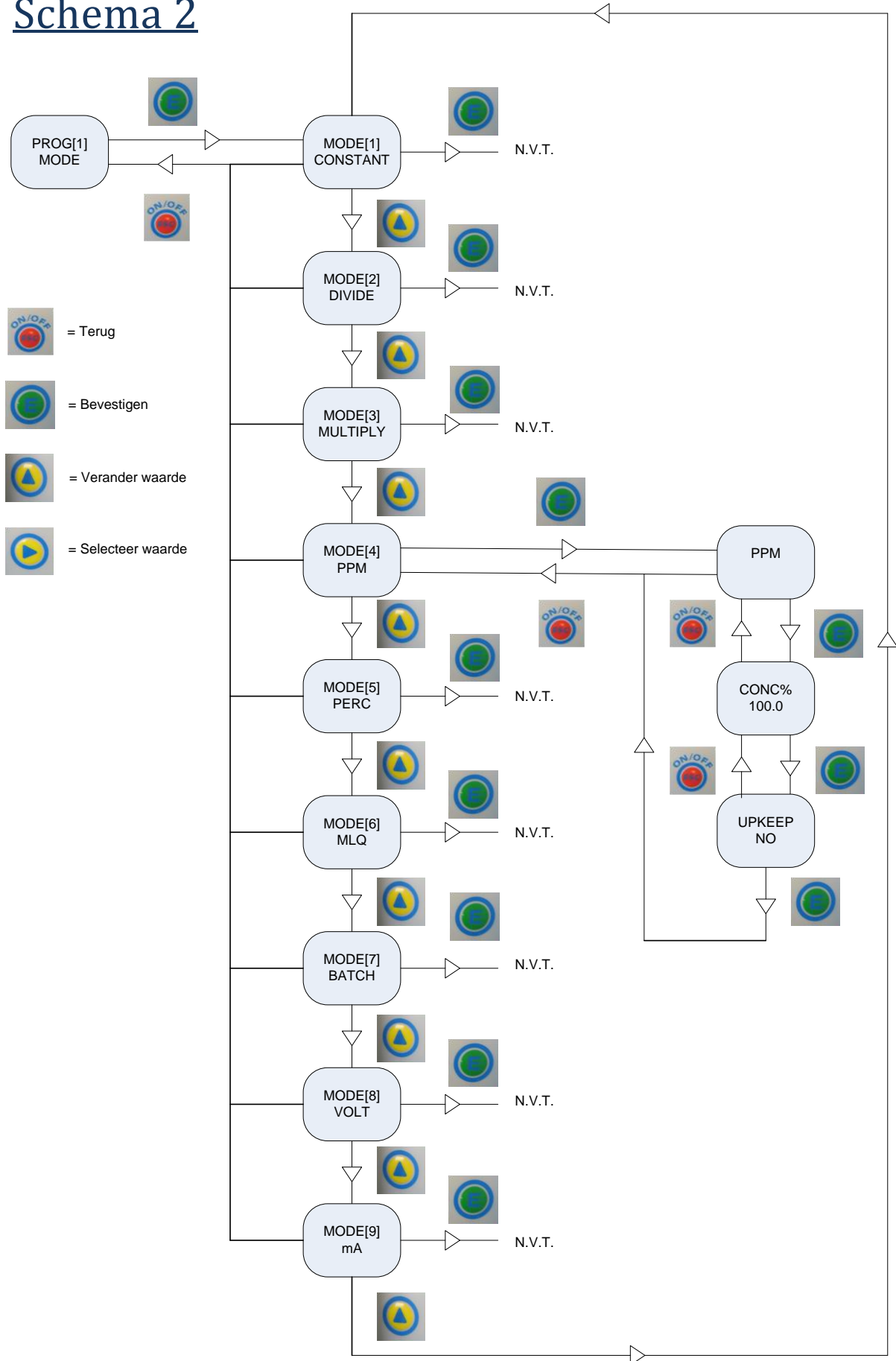

Schema 3

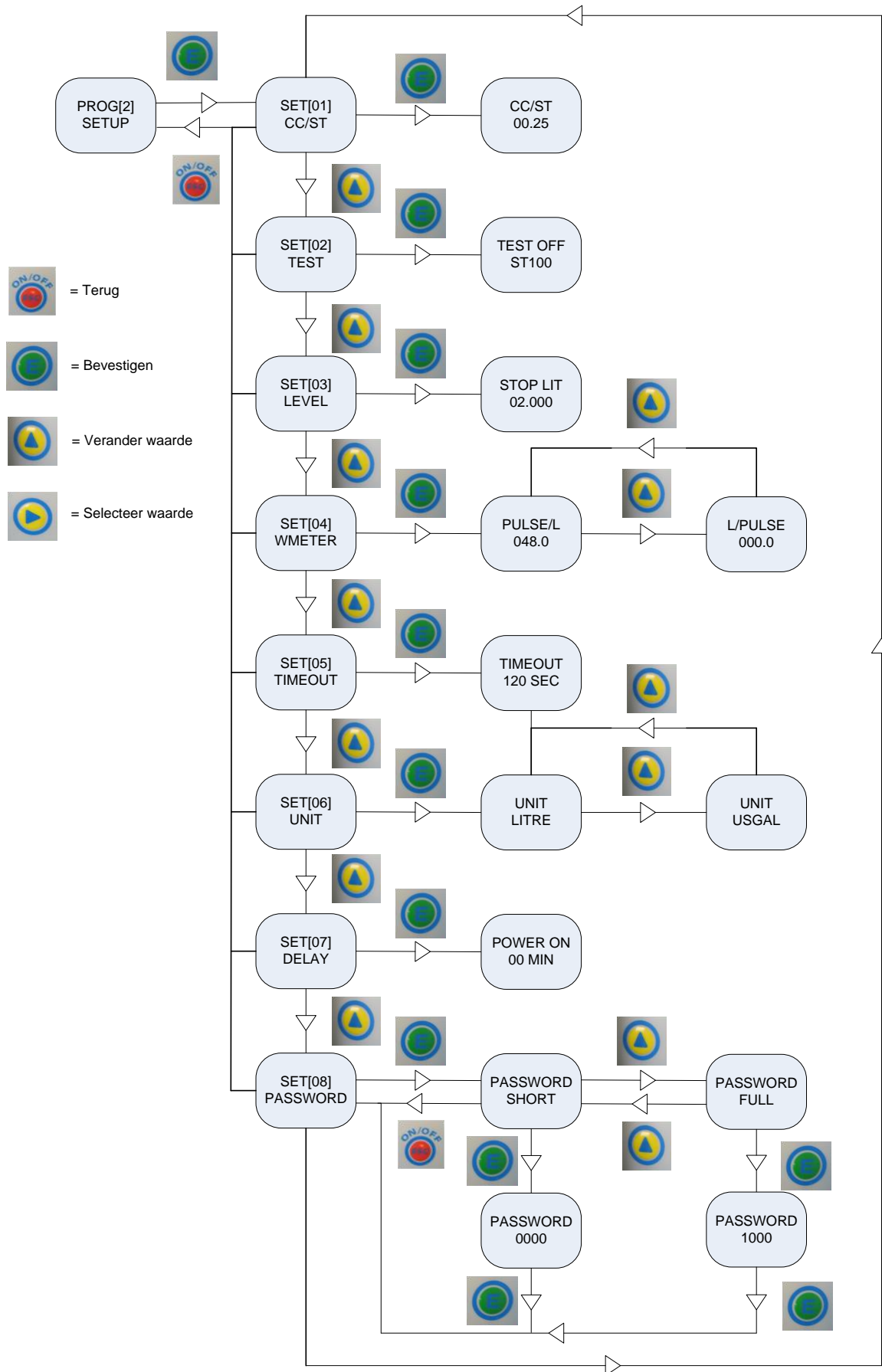

Follow the steps below to modify dosage:

Schema 4

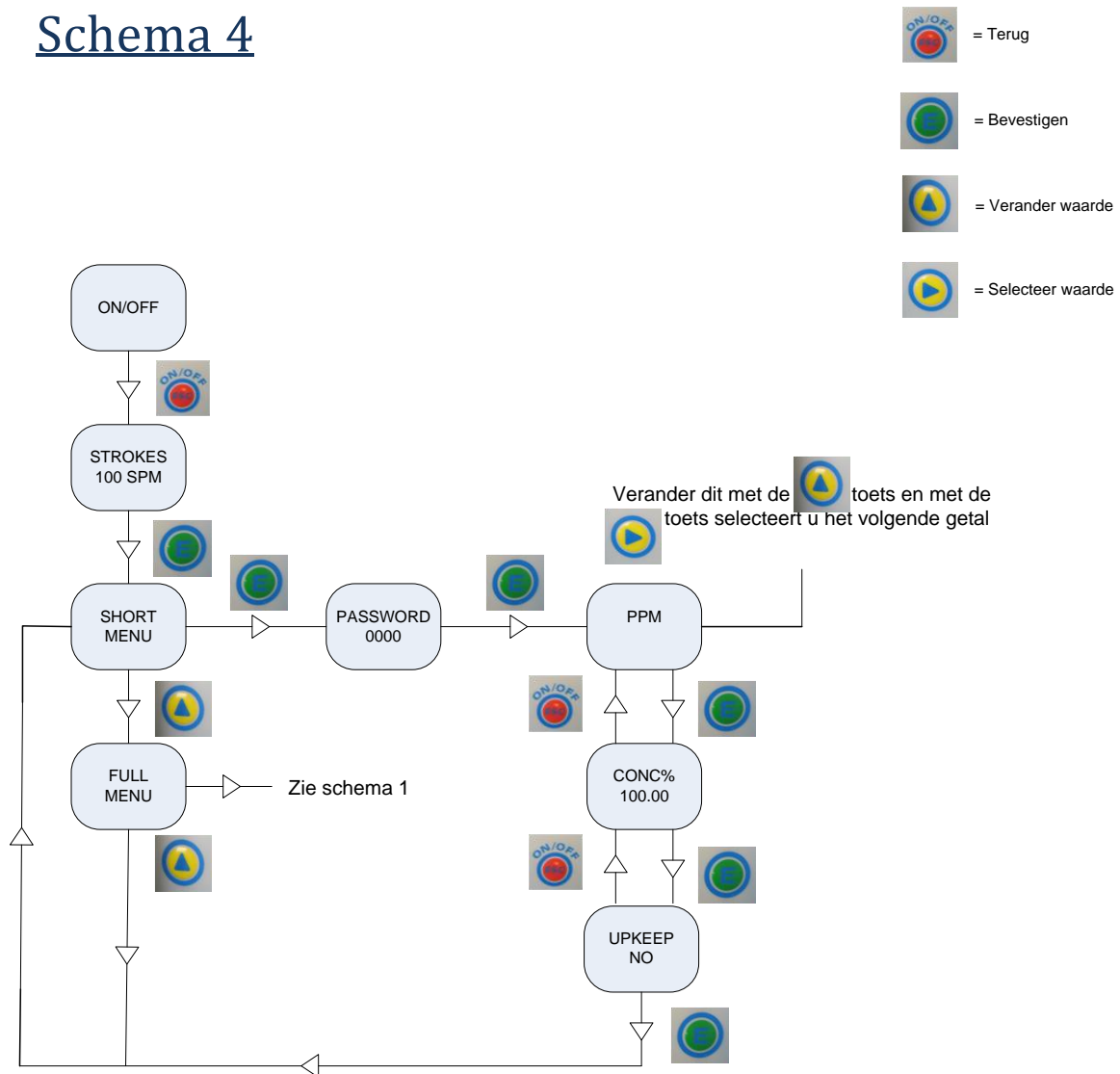

After modification, and when you are back in the short menu, press the ESC button twice to go back.

Schema 1

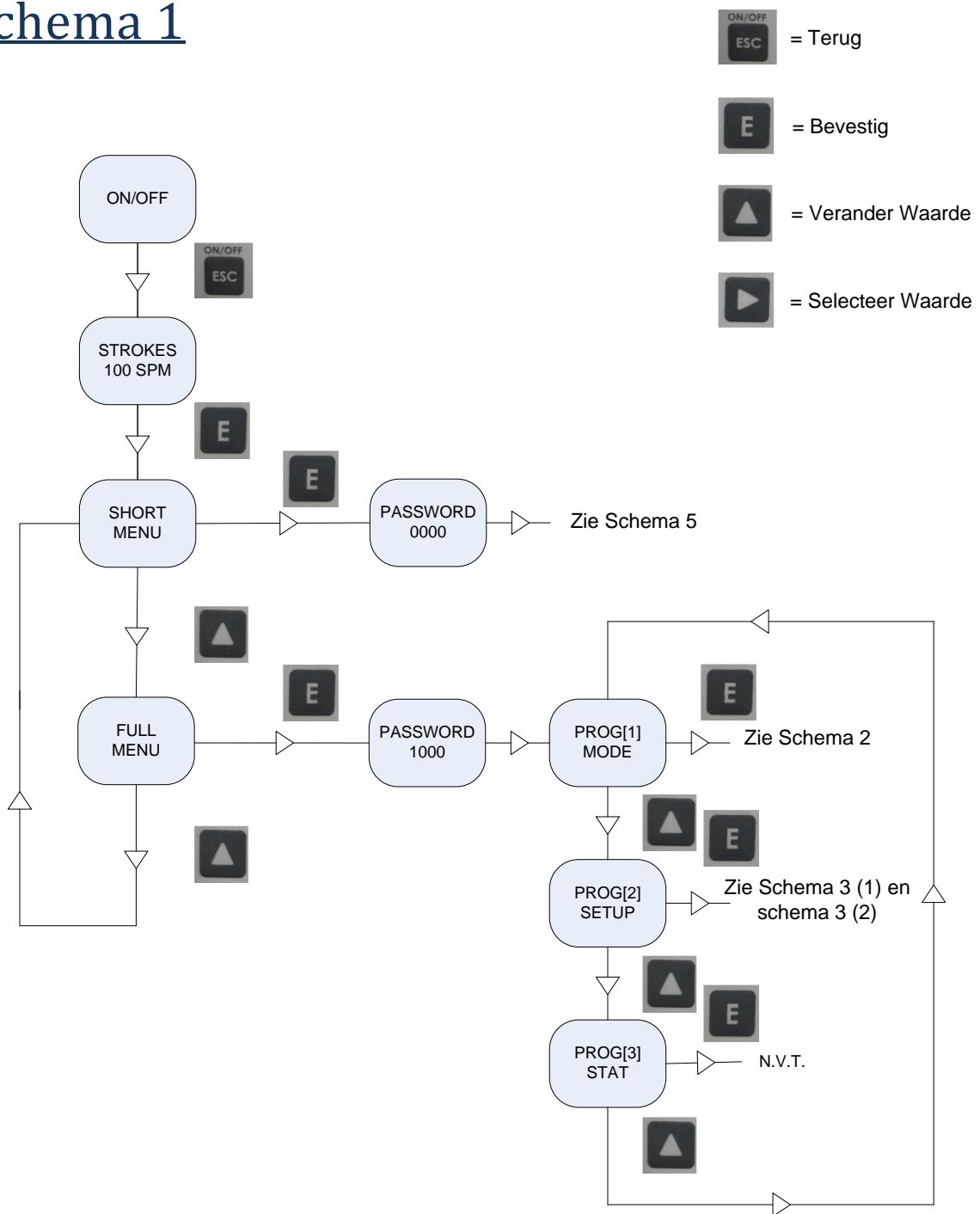

Schema 2

-  = Terug
-  = Bevestig
-  = Verander Waarde
-  = Selecteer Waarde

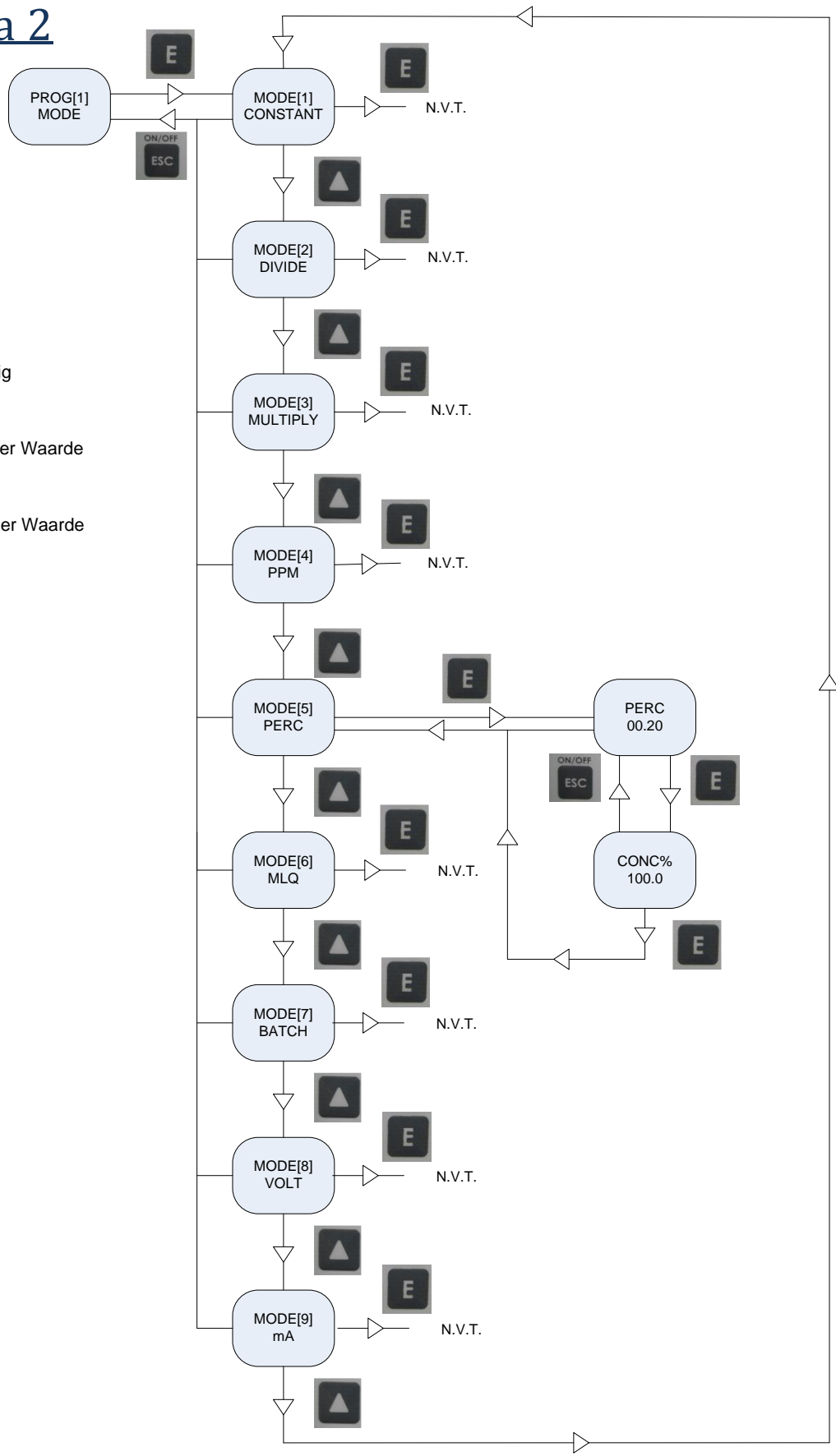

Schema 3 (1)

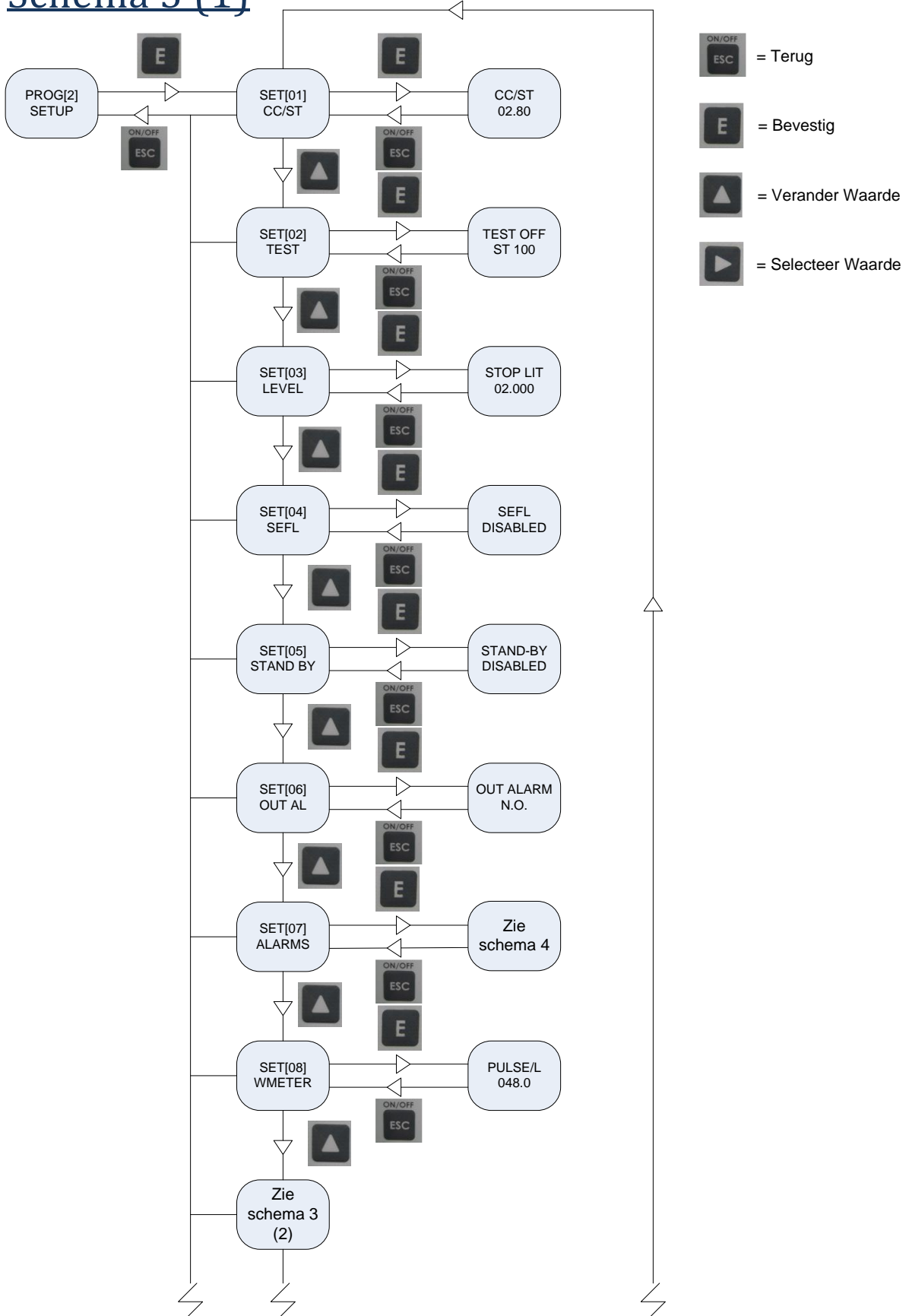

Schema 3 (2)

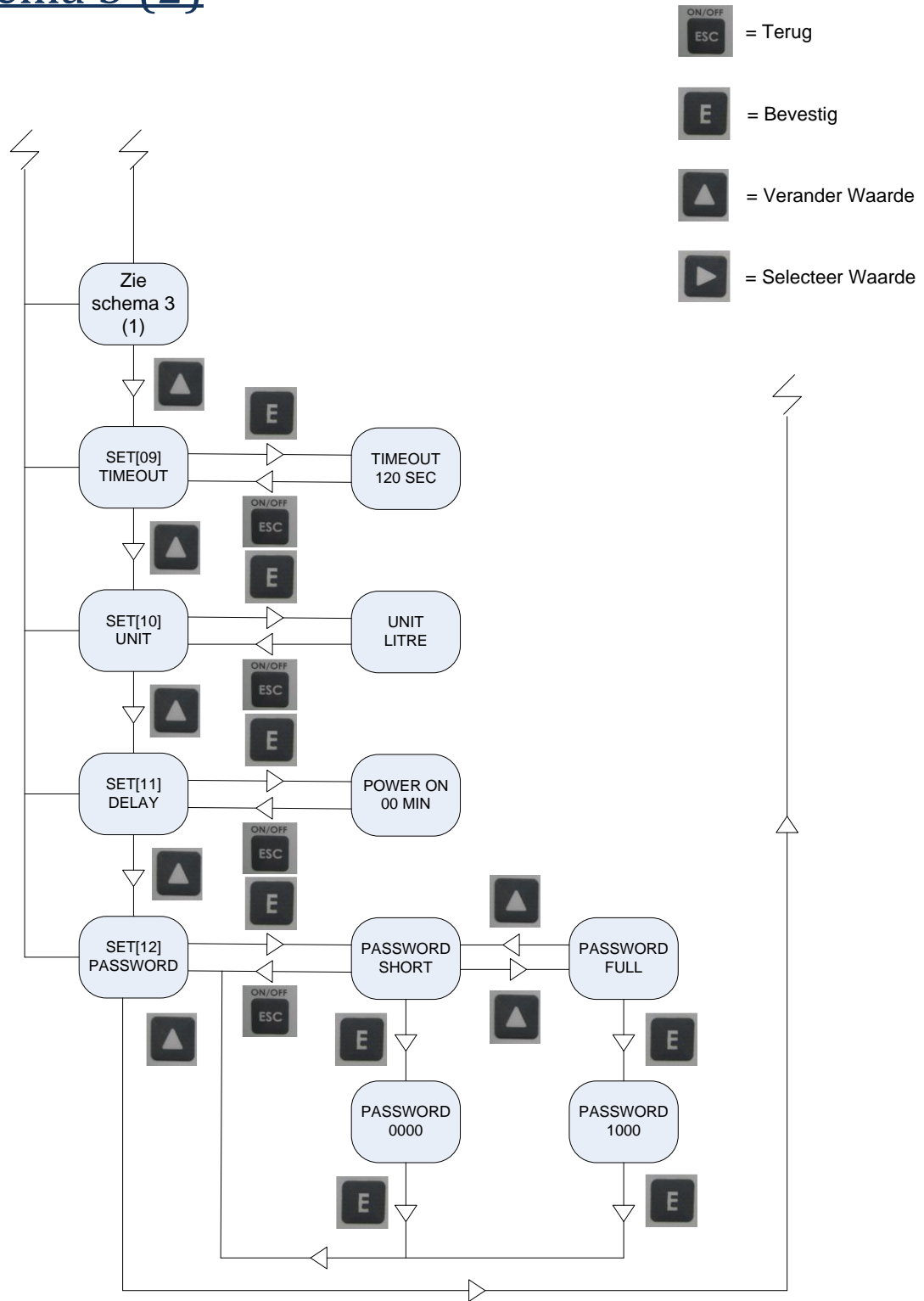

Schema 4

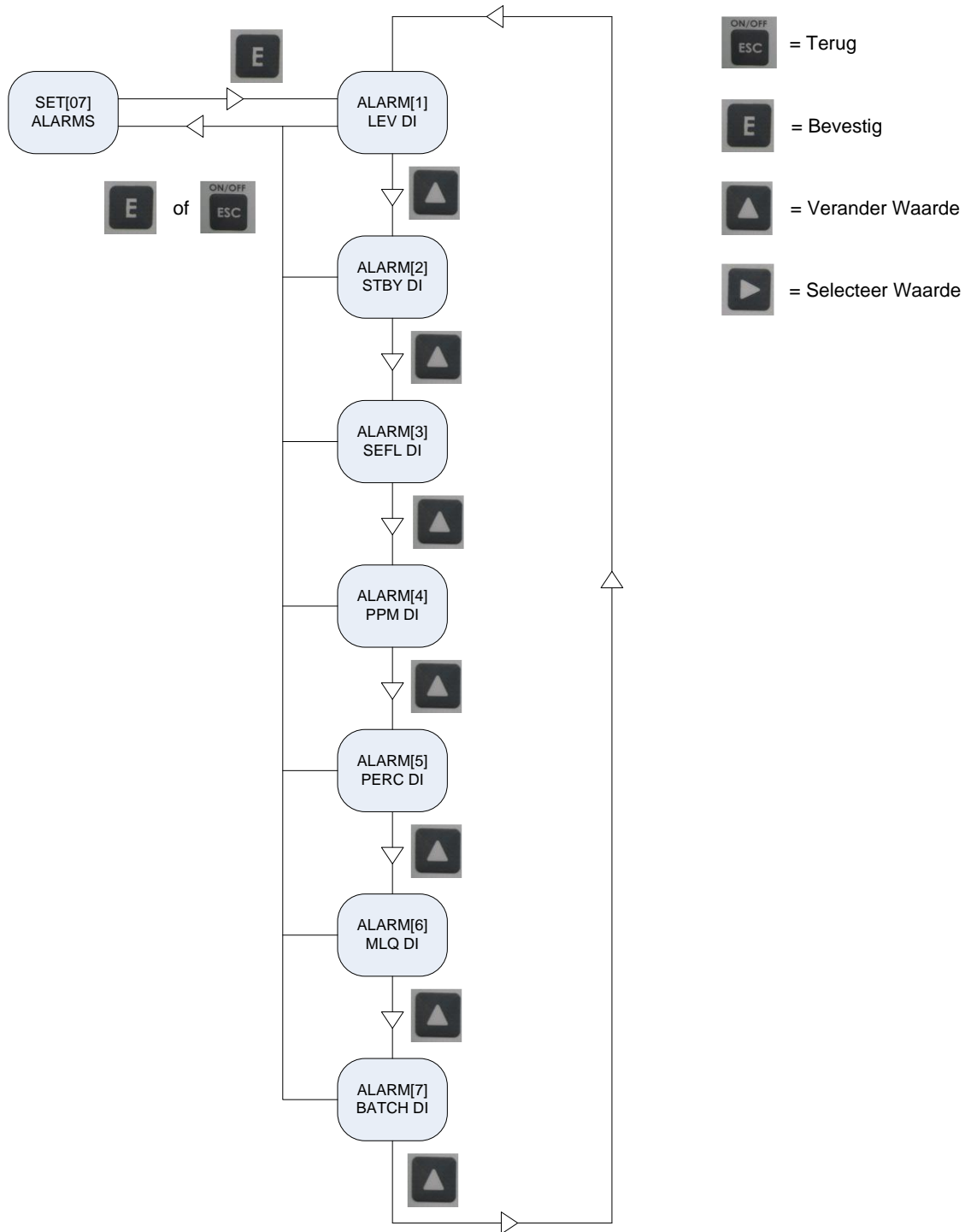

5. MAINTENANCE

5.1 Cleaning the pump

When the pump has been idle for an extended period, we advise flushing the device by sucking up a few litres of clean water.

6. TROUBLE SHOOTING

PROBLEM	CAUSE	SOLUTION
Fault handling	General	Press ⏻ until "alarm" shows in the display. Then press ⏻ to see notification of the fault in question.
Dosage is not accurate	Wrong setting	Check the percentage or PPM, concentration and number of water meter pulses
	Excessive pressure	Set the pressure to Max. 5 bar while water is released by the pressure reducing valve
	Foot filter blocked or defective	Clean or replace the foot filter
	Pump head valves, foot filter or injector blocked or damaged.	Replace or clean the defective or dirty parts
	Electromagnet not delivering sufficient power (dull sound)	Send the pump to the repair service
Dosage too high	Injector Wrong injector mounted Defective injector	Check the injector (number 5 on the injector)
Product/water drains back into the supply tank	Defective/dirty injector or valve	Replace/clean the injector and/or the valves
	Checking the injector	Screw the pressure hose off, and if water leaks from the injector, replace it Or Screw the pressure hose off. Let the pump dose. Seal the pressure hose with your thumb. If the injector remains blocked with enough pressure, → replace it.
The water meter is running and no product is dosed	Carry out the following test: Disconnect the water meter cable from the pump and connect the dry-run protection cable to it. Take the foot valve out of the supply tank and move the float up and down.	The pump should now inject with the movements of the float. If it does not, you should send the pump in for repair. If it does work, you need to replace the water meter's sensor, cable or the whole meter.

PROBLEM	CAUSE	SOLUTION
Strange symbols show on the display or certain pump functions are no longer accessible through the buttons	Fault on the printed circuit	Reset. Switch off the pump with the "ESC" button. Take the plug out of the power outlet. Press both arrow buttons and hold them down while reconnecting the power plug. The screen shows "load default" Reprogram the pump. If this does not succeed, you should send the pump in for repair.
Display/pump does not work	Power supply interrupted	Check the power supply
	Faulty fuse	Screw off the cover on the back of the pump and check/replace the fuse. If the problem recurs, send the pump in for repair
	Defective printed circuit	Send the pump to the repair service
Alarm "low level in the tank" # flashing (→ alarm 1 level)	To pump the tank completely empty, a certain number of reserve litres are programmed. The pump keeps on working until this reserve is gone.	Possibly modify the reserve setting for the supply tank.
Pump doses continuously	Press  and read the mode from the display	Check the settings % PPM Continuous Impulse/litre (not litre/impulse)